

N-Channel Enhancement Mode Power MOSFET

● Features

V_{DS}	$R_{DS(ON)TYP}$	I_D
30V	10 mΩ@10V	46A
	15 mΩ@4.5V	

● General Description

- DC/DC Converters in Computing, Servers and POL
- Isolated DC/DC Converters in Telecom and Industrial

● Pin Configurations

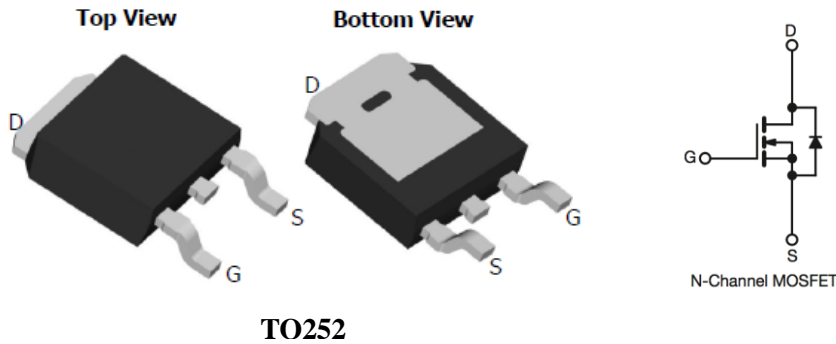

● Absolute Maximum Ratings @ $T_A=25^\circ\text{C}$ unless otherwise noted

Parameter		Symbol	Ratings	Unit
Drain-Source Voltage		V_{DSS}	30	V
Gate-Source Voltage		V_{GSS}	± 20	V
Drain Current (Continuous) *AC	$T_A=25^\circ\text{C}$	I_D	46	A
	$T_A=70^\circ\text{C}$		36	
Drain Current (Pulse) *B		I_{DM}	20.5	A
Power Dissipation	$T_A=25^\circ\text{C}$	P_D	20.8	W
Operating Temperature/ Storage Temperature		T_J/T_{STG}	-55~150	$^\circ\text{C}$

● Thermal Resistance Ratings

Parameter		Symbol	Typical	Maximum	Unit
Maximum Junction-to-Ambient	Steady State	R_{thJA}	40	50	$^\circ\text{C/W}$
	Maximum Junction-to-Case (Drain)	R_{thJC}	3.3	4	

Electrical Characteristics

$T_A=25^{\circ}\text{C}$ unless otherwise noted

Parameter	Symbol	Test Conditions	Min	Typ	Max	Unit
Static						
Drain-Source Breakdown Voltage	$V_{(BR)DSS}$	$V_{GS} = 0V, I_D = 250 \mu A$	30	--	--	V
Zero Gate Voltage Drain Current	I_{DSS}	$V_{DS} = 30V, V_{GS} = 0V$	--	--	1	μA
Gate Threshold Voltage	$V_{GS(TH)}$	$V_{GS} = V_{DS}, I_{DS} = 250 \mu A$	1	1.5	2	V
Gate Leakage Current	I_{GSS}	$V_{GS} = \pm 20V, V_{DS} = 0V$	--	--	± 100	nA
Drain-Source On-state Resistance	$R_{DS(on)}$	$V_{GS} = 10V, I_D = 20A$	--	10	15	m Ω
	$R_{DS(on)}$	$V_{GS} = 4.5V, I_D = 10A$	--	15	20	m Ω
Forward Transconductance	g_{FS}	$V_{DS} = 5V, I_D = 20A$	--	42	--	S
Diode Forward Voltage	V_{SD}	$I_{SD} = 1A, V_{GS} = 0V$	--	--	1.1	V
Diode Forward Current	I_S	$TC = 25^{\circ}\text{C}$	--	--	42	A
Switching						
Total Gate Charge	Q_g	$V_{GS} = 10V, V_{DS} = 15V, I_D = 20A$	--	14	--	nC
Gate-Source Charge	Q_{gs}		--	3	--	nC
Gate-Drain Charge	Q_{gd}		--	2.5	--	nC
Turn-on Delay Time	$t_{d(on)}$	$V_{GS} = 10V, V_{DS} = 15V, R_L = 0.75\Omega, R_{GEN} = 3\Omega$	--	7	--	ns
Turn-on Rise Time	t_r		--	13.5	--	ns
Turn-off Delay Time	$t_{d(off)}$		--	18.5	--	ns
Turn-Off Fall Time	t_f		--	4	--	ns
Dynamic						
Input Capacitance	C_{iss}	$V_{DS} = 15V, V_{GS} = 0V, f = 1.0\text{MHz}$	--	1140	--	pF
Output Capacitance	C_{oss}		--	400	--	pF
Reverse Transfer Capacitance	C_{rss}		--	45	--	pF

A: The value of $R_{\theta JA}$ is measured with the device mounted on 1in² FR-4 board with 2oz. Copper, in a still air environment with $T_A=25^{\circ}\text{C}$. The value in any given application depends on the user's specific board design.

B: Repetitive rating, pulse width limited by junction temperature.

C: The current rating is based on the $t \leq 10\text{s}$ junction to ambient thermal resistance rating.

Typical Electrical and Thermal Characteristics

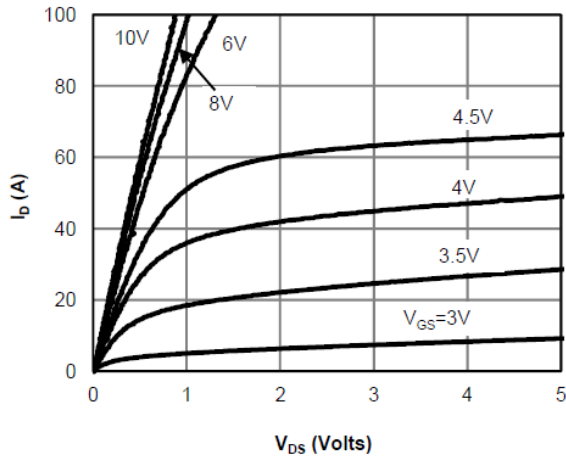

Figure 1: On-Region Characteristics

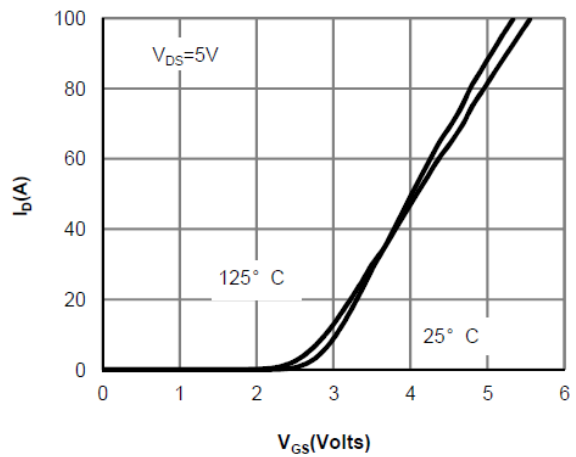

Figure 2: Transfer Characteristics

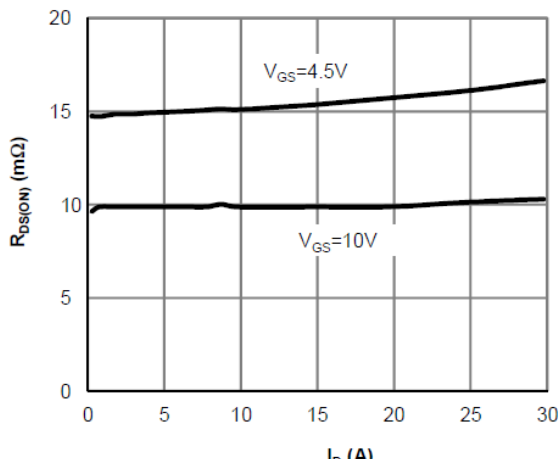

Figure 3: On-Resistance vs. Drain Current and Gate Voltage

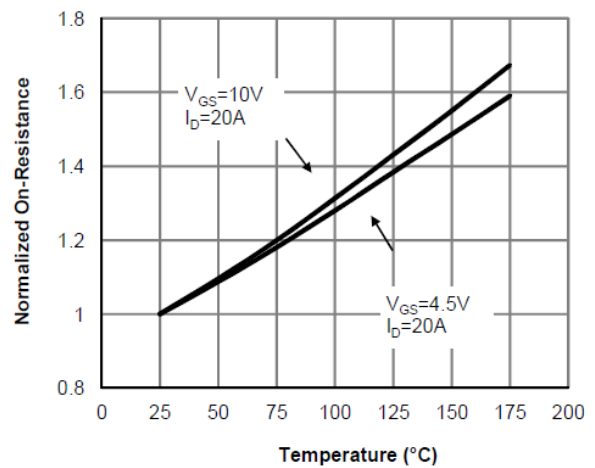

Figure 4: On-Resistance vs. Junction Temperature

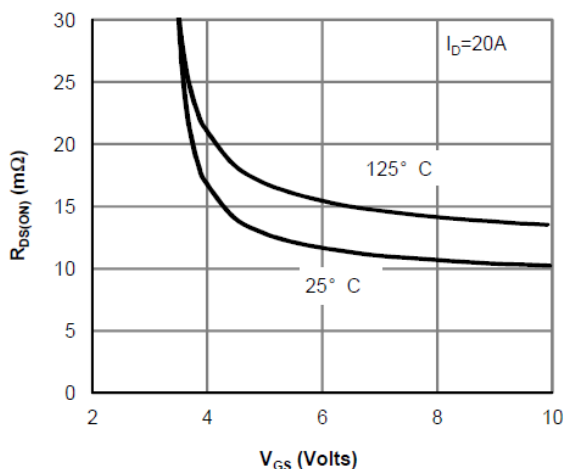

Figure 5: On-Resistance vs. Gate-Source Voltage

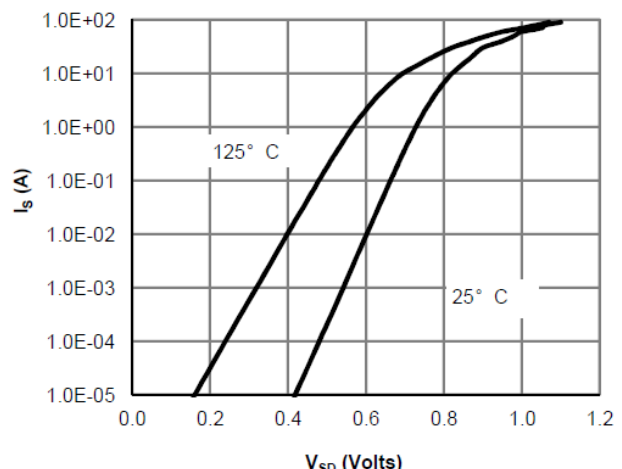

Figure 6: Body-Diode Characteristics

Typical Electrical and Thermal Characteristics

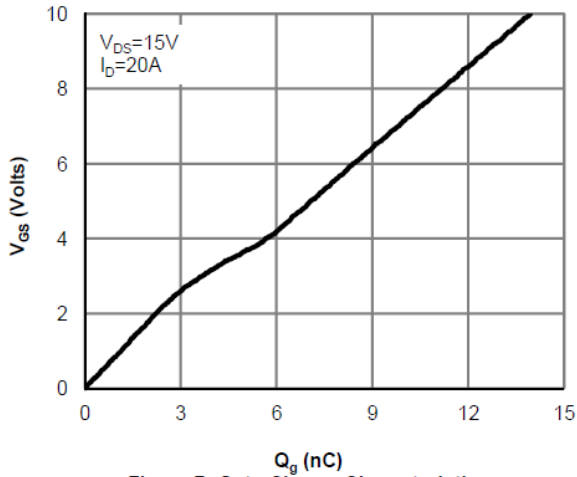

Figure 7: Gate-Charge Characteristics

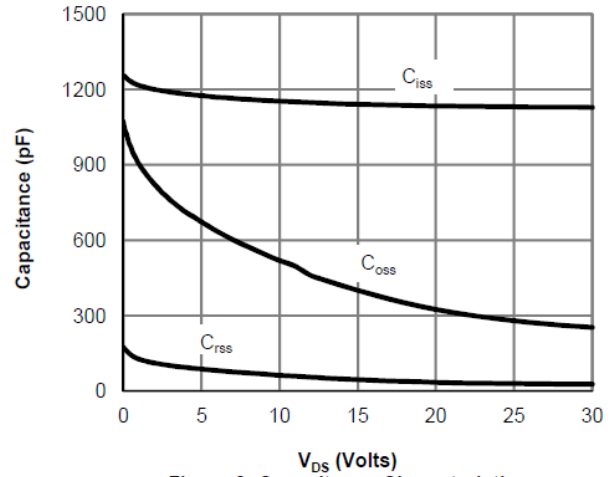

Figure 8: Capacitance Characteristics

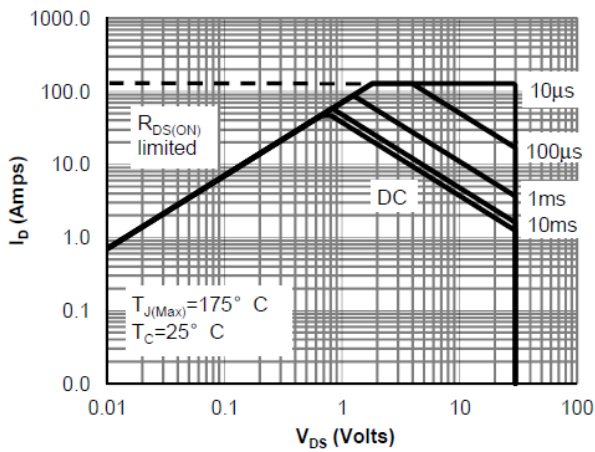

Figure 9: Maximum Forward Biased Safe Operating Area

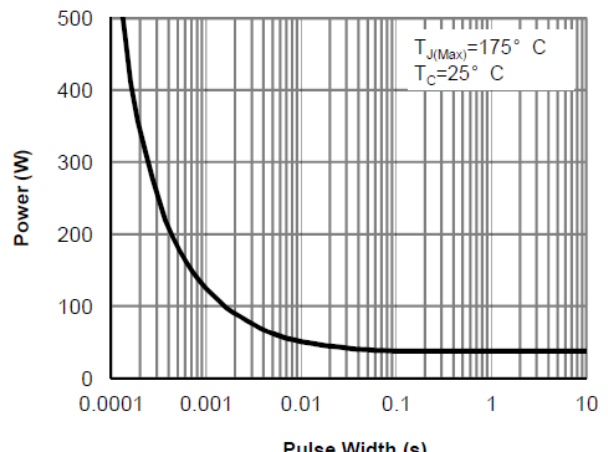

Figure 10: Single Pulse Power Rating Junction-to-Case

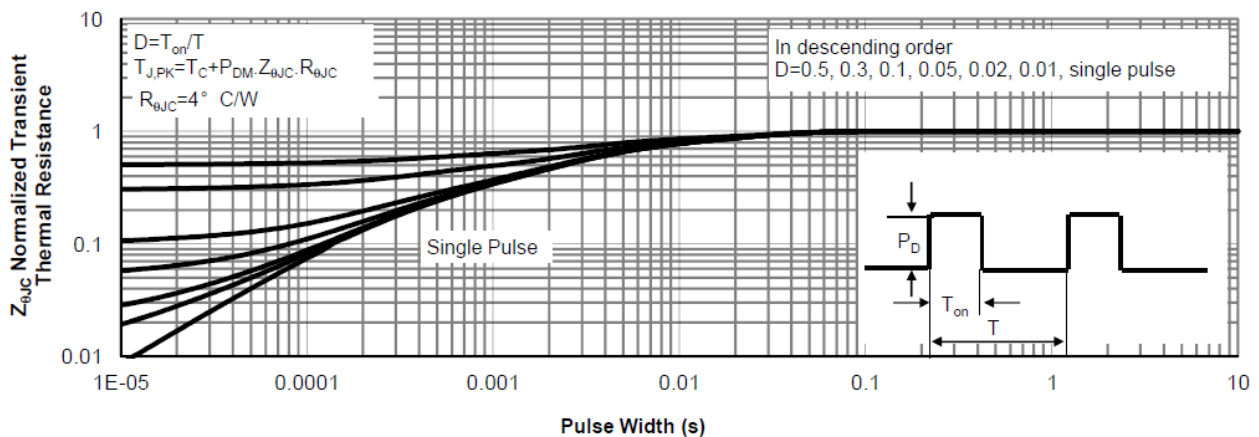

Figure 11: Normalized Maximum Transient Thermal Impedance

Typical Electrical and Thermal Characteristics

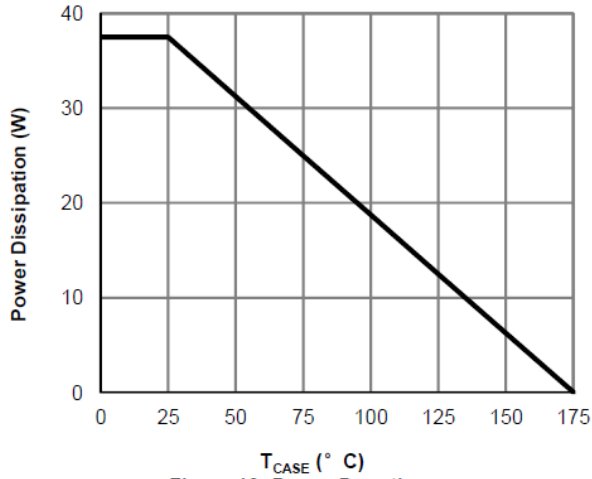

Figure 12: Power De-rating

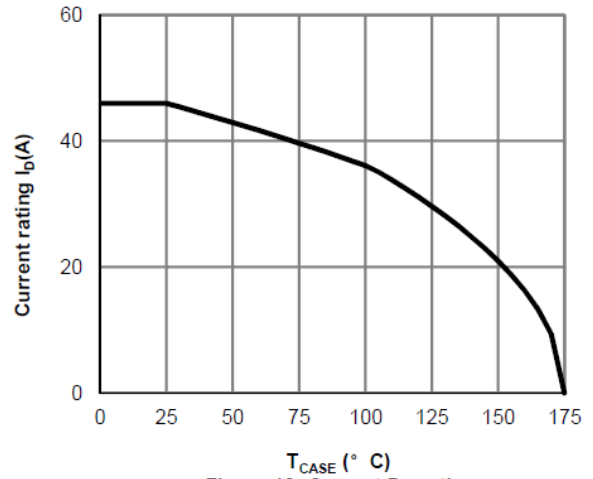

Figure 13: Current De-rating

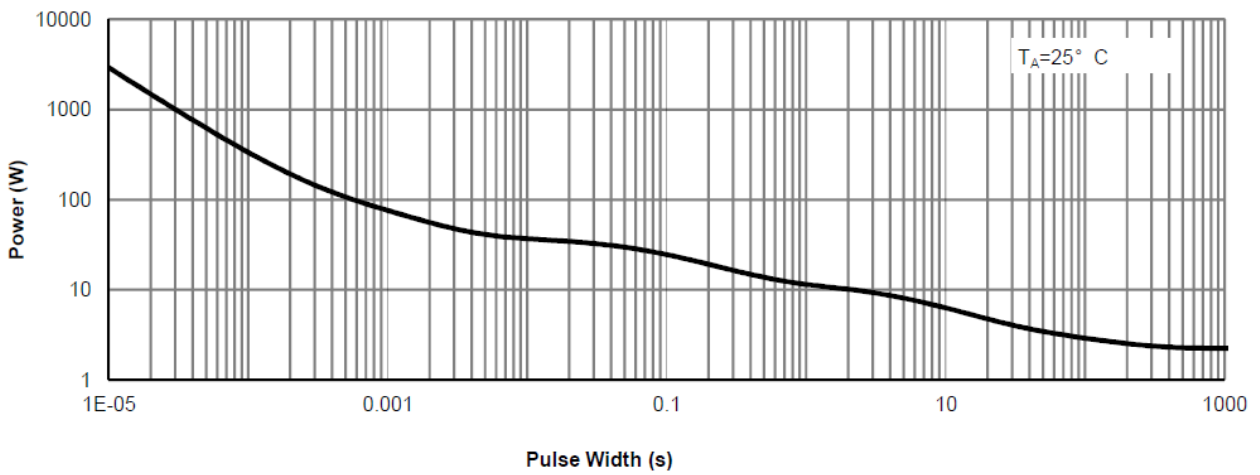

Figure 14: Single Pulse Power Rating Junction-to-Ambient

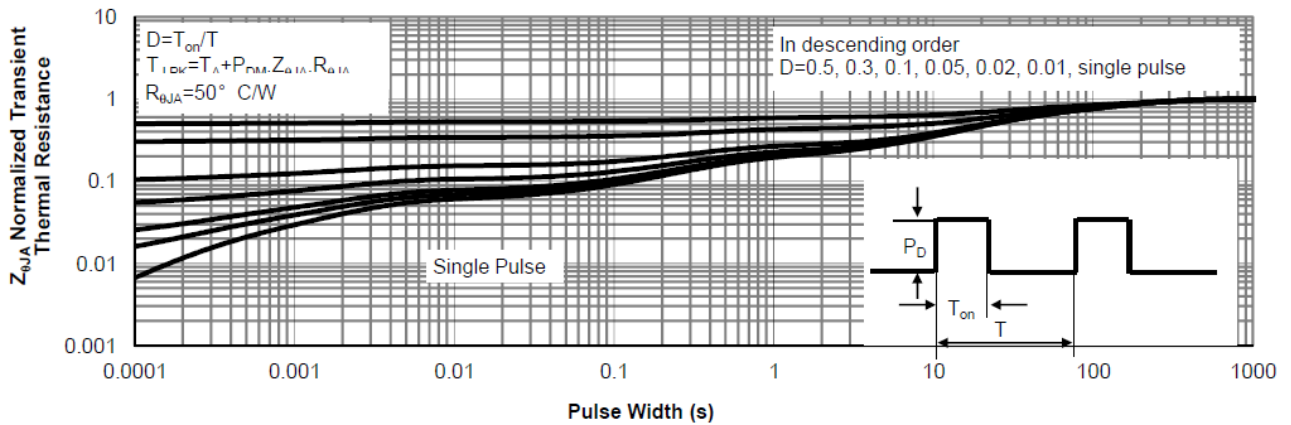
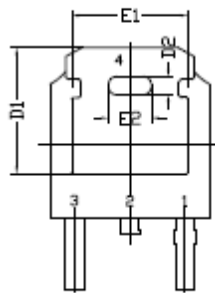
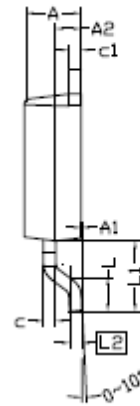
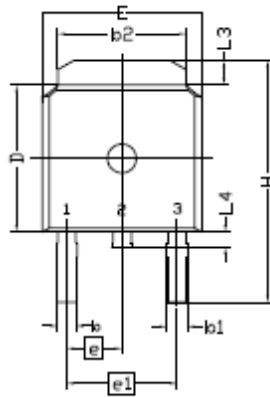
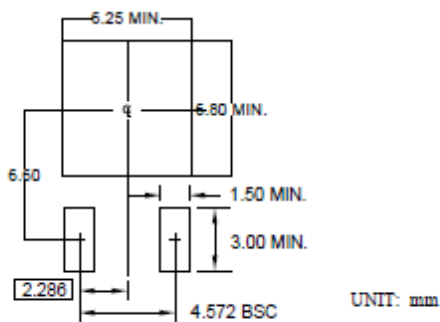

Figure 15: Normalized Maximum Transient Thermal Impedance

Package Information



RECOMMENDED LAND PATTERN



NOTE

1. PACKAGE BODY SIZES EXCLUDE MOLD FLASH AND GATE BURRS. MOLD FLASH SHOULD BE LESS THAN 6 MILS.
2. DIMENSION L IS MEASURED IN GAUGE PLANE
3. TOLERANCE 0.10 mm UNLESS OTHERWISE SPECIFIED
4. CONTROLLING DIMENSION IS MILLIMETER. CONVERTED INCH DIMENSIONS ARE NOT NECESSARILY EXACT.
5. REFER TO JEDEC TO-252 (AA)

DIMENSION	DIMENSION IN MILLIMETERS			DIMENSIONS IN INCHES		
	MIN.	NOM.	MAX.	MIN.	NOM.	MAX.
A	2.184	2.286	2.388	0.086	0.090	0.094
A1	0.000	---	0.127	0.000	---	0.005
A2	0.889	1.041	1.143	0.035	0.041	0.045
b	0.635	0.762	0.889	0.025	0.030	0.035
b1	0.762	0.840	1.143	0.030	0.033	0.045
b2	4.953	5.340	5.461	0.195	0.210	0.215
c	0.450	0.508	0.610	0.018	0.020	0.024
c1	0.450	0.508	0.610	0.018	0.020	0.024
D	5.969	6.096	6.223	0.235	0.240	0.245
D1	5.210	5.249	5.380	0.205	0.207	0.212
D2	0.662	0.762	0.862	0.026	0.030	0.034
E	6.350	6.604	6.731	0.250	0.260	0.265
E1	4.318	4.826	4.901	0.170	0.190	0.193
E2	1.678	1.778	1.878	0.066	0.070	0.074
e	2.286 BSC			0.090 BSC		
e1	4.572 BSC			0.180 BSC		
H	9.398	10.033	10.414	0.370	0.395	0.410
L	1.270	1.520	2.032	0.050	0.060	0.080
L1	2.921 REF.			0.115 REF.		
L2	0.408	0.508	0.608	0.016	0.020	0.024
L3	0.889	1.016	1.270	0.035	0.040	0.050
L4	0.635	---	1.016	0.025	---	0.040